

© International Baccalaureate Organization 2021

All rights reserved. No part of this product may be reproduced in any form or by any electronic or mechanical means, including information storage and retrieval systems, without the prior written permission from the IB. Additionally, the license tied with this product prohibits use of any selected files or extracts from this product. Use by third parties, including but not limited to publishers, private teachers, tutoring or study services, preparatory schools, vendors operating curriculum mapping services or teacher resource digital platforms and app developers, whether fee-covered or not, is prohibited and is a criminal offense.

More information on how to request written permission in the form of a license can be obtained from <https://ibo.org/become-an-ib-school/ib-publishing/licensing/applying-for-a-license/>.

© Organisation du Baccalauréat International 2021

Tous droits réservés. Aucune partie de ce produit ne peut être reproduite sous quelque forme ni par quelque moyen que ce soit, électronique ou mécanique, y compris des systèmes de stockage et de récupération d'informations, sans l'autorisation écrite préalable de l'IB. De plus, la licence associée à ce produit interdit toute utilisation de tout fichier ou extrait sélectionné dans ce produit. L'utilisation par des tiers, y compris, sans toutefois s'y limiter, des éditeurs, des professeurs particuliers, des services de tutorat ou d'aide aux études, des établissements de préparation à l'enseignement supérieur, des fournisseurs de services de planification des programmes d'études, des gestionnaires de plateformes pédagogiques en ligne, et des développeurs d'applications, moyennant paiement ou non, est interdite et constitue une infraction pénale.

Pour plus d'informations sur la procédure à suivre pour obtenir une autorisation écrite sous la forme d'une licence, rendez-vous à l'adresse <https://ibo.org/become-an-ib-school/ib-publishing/licensing/applying-for-a-license/>.

© Organización del Bachillerato Internacional, 2021

Todos los derechos reservados. No se podrá reproducir ninguna parte de este producto de ninguna forma ni por ningún medio electrónico o mecánico, incluidos los sistemas de almacenamiento y recuperación de información, sin la previa autorización por escrito del IB. Además, la licencia vinculada a este producto prohíbe el uso de todo archivo o fragmento seleccionado de este producto. El uso por parte de terceros —lo que incluye, a título enunciativo, editoriales, profesores particulares, servicios de apoyo académico o ayuda para el estudio, colegios preparatorios, desarrolladores de aplicaciones y entidades que presten servicios de planificación curricular u ofrezcan recursos para docentes mediante plataformas digitales—, ya sea incluido en tasas o no, está prohibido y constituye un delito.

En este enlace encontrará más información sobre cómo solicitar una autorización por escrito en forma de licencia: <https://ibo.org/become-an-ib-school/ib-publishing/licensing/applying-for-a-license/>.

Physics
Higher level
Paper 1

Thursday 4 November 2021 (afternoon)

1 hour

Instructions to candidates

- Do not open this examination paper until instructed to do so.
- Answer all the questions.
- For each question, choose the answer you consider to be the best and indicate your choice on the answer sheet provided.
- A clean copy of the **physics data booklet** is required for this paper.
- The maximum mark for this examination paper is **[40 marks]**.

1. A ball of mass $(50 \pm 1)\text{g}$ is moving with a speed of $(25 \pm 1)\text{ms}^{-1}$. What is the fractional uncertainty in the momentum of the ball?
- A. 0.02
 - B. 0.04
 - C. 0.06
 - D. 0.08
2. The graph shows the variation with time t of the velocity of an object.

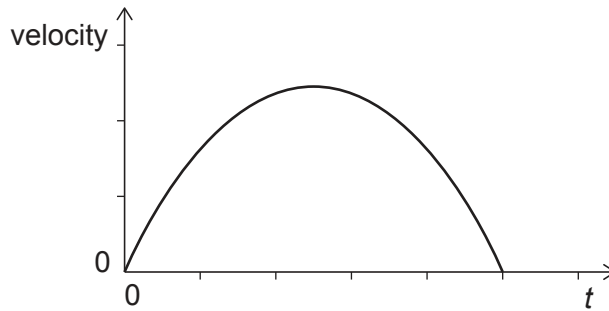

What is the variation with time t of the acceleration of the object?

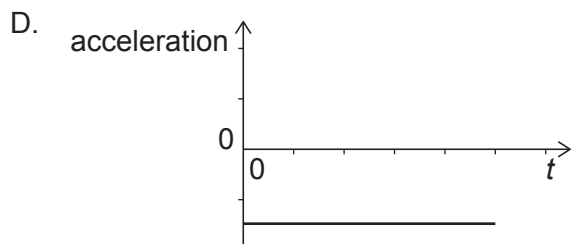
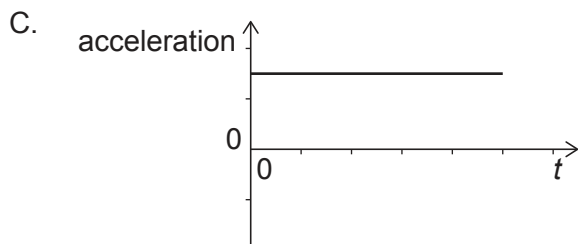
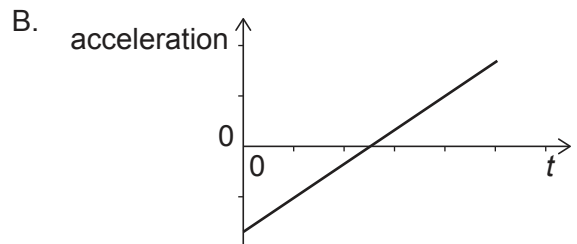
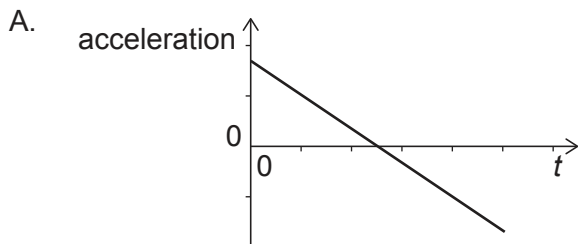

3. X and Y are two objects on a frictionless table connected by a string. The mass of X is 2 kg and the mass of Y is 4 kg. The mass of the string is negligible. A constant horizontal force of 12 N acts on Y.

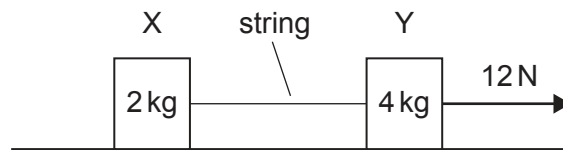

What are the acceleration of Y and the magnitude of the tension in the string?

	Acceleration of Y/ ms^{-2}	Tension in the string/N
A.	2	4
B.	2	6
C.	3	4
D.	3	6

4. A net force F acts on an object of mass m that is initially at rest. The object moves in a straight line. The variation of F with the distance s is shown.

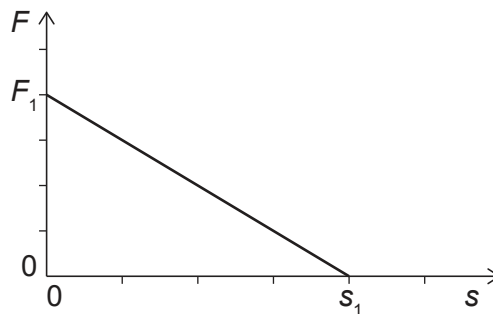

What is the speed of the object at the distance s_1 ?

- A. $\sqrt{\frac{F_1 s_1}{2m}}$
- B. $\sqrt{\frac{F_1 s_1}{m}}$
- C. $\sqrt{\frac{2F_1 s_1}{m}}$
- D. $\sqrt{\frac{4F_1 s_1}{m}}$

Turn over

5. A cyclist rides up a hill of vertical height 100 m in 500 s at a constant speed. The combined mass of the cyclist and the bicycle is 80 kg. The power developed by the cyclist is 200 W. What is the efficiency of the energy transfer in this system?

- A. 8%
- B. 20%
- C. 60%
- D. 80%

6. A block rests on a frictionless horizontal surface. An air rifle pellet is fired horizontally into the block and remains embedded in the block.

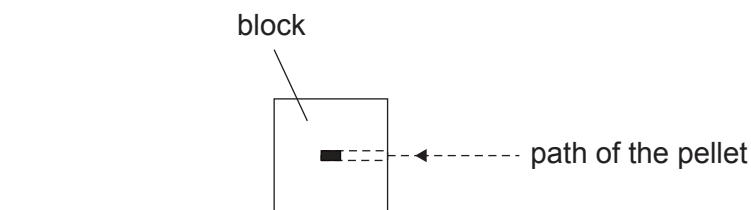

What happens to the total kinetic energy and to the total momentum of the block and pellet system as a result of the collision?

	Total kinetic energy	Total momentum
A.	no change	no change
B.	no change	decreases
C.	decreases	no change
D.	decreases	decreases

7. A ball rolls on the floor towards a wall and rebounds with the same speed and at the same angle to the wall.

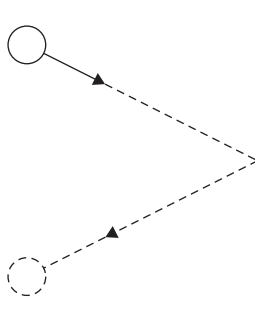

What is the direction of the impulse applied to the ball by the wall?

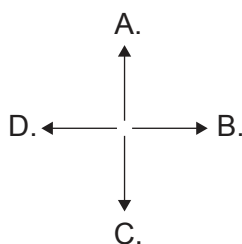

8. A liquid is vaporized to a gas at a constant temperature.

Three quantities of the substance are the

- I. total intermolecular potential energy
- II. root mean square speed of the molecules
- III. average distance between the molecules.

Which quantities are **greater** for the substance in the gas phase compared to the liquid phase?

- A. I and II only
- B. I and III only
- C. II and III only
- D. I, II and III

Turn over

9. An insulated container of negligible mass contains a mass $2M$ of a liquid. A piece of a metal of mass M is dropped into the liquid. The temperature of the liquid increases by 10°C and the temperature of the metal decreases by 80°C in the same time.

What is $\frac{\text{specific heat capacity of the liquid}}{\text{specific heat capacity of the metal}}$?

- A. 2
 B. 4
 C. 8
 D. 16
10. The molar mass of an ideal gas is M . A fixed mass m of the gas expands at a constant pressure p . The graph shows the variation with temperature T of the gas volume V .

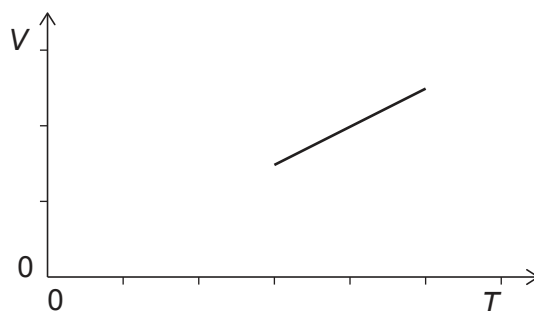

What is the gradient of the graph?

- A. $\frac{Mp}{mR}$
 B. $\frac{MR}{mp}$
 C. $\frac{mp}{MR}$
 D. $\frac{mR}{Mp}$

11. A travelling wave on the surface of a lake has wavelength λ . Two points along the wave oscillate with the phase difference of π . What is the smallest possible distance between these two points?

- A. $\frac{\lambda}{4}$
- B. $\frac{\lambda}{2}$
- C. λ
- D. 2λ

12. Horizontally polarized light is incident on a pair of polarizers X and Y. The axis of polarization of X makes an angle θ with the horizontal. The axis of polarization of Y is vertical.

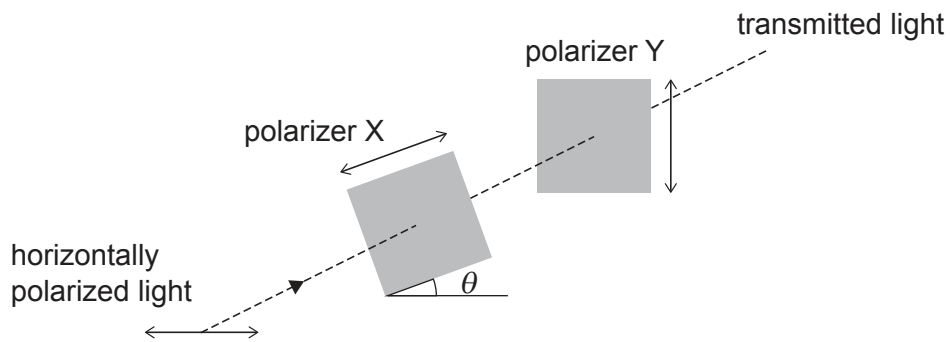

What is θ so that the intensity of the light transmitted through Y is a maximum?

- A. 0°
- B. 45°
- C. 90°
- D. 180°

13. The diagram shows an interference pattern observed on a screen in a double-slit experiment with monochromatic light of wavelength 600 nm. The screen is 1.0 m from the slits.

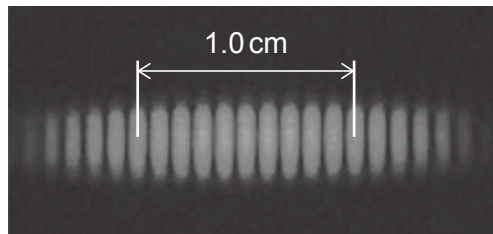

What is the separation of the slits?

- A. $6.0 \times 10^{-7} \text{ m}$
 - B. $6.0 \times 10^{-6} \text{ m}$
 - C. $6.0 \times 10^{-5} \text{ m}$
 - D. $6.0 \times 10^{-4} \text{ m}$
14. A string is fixed at both ends. P and Q are two particles on the string.



The first harmonic standing wave is formed in the string. What is correct about the motion of P and Q?

- A. P is a node and Q is an antinode.
- B. P is an antinode and Q is a node.
- C. P and Q oscillate with the same amplitude.
- D. P and Q oscillate with the same frequency.

15. A charge $+Q$ and a charge $-2Q$ are a distance $3x$ apart. Point P is on the line joining the charges, at a distance x from $+Q$.

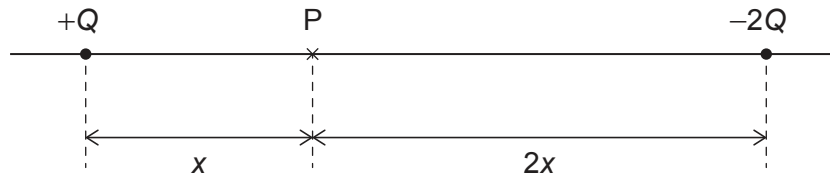

The magnitude of the electric field produced at P by the charge $+Q$ alone is E .

What is the total electric field at P?

- A. $\frac{E}{2}$ to the right
- B. $\frac{E}{2}$ to the left
- C. $\frac{3E}{2}$ to the right
- D. $\frac{3E}{2}$ to the left
16. Two wires, X and Y, are made of the same material and have equal length. The diameter of X is twice that of Y.

What is $\frac{\text{resistance of X}}{\text{resistance of Y}}$?

- A. $\frac{1}{4}$
- B. $\frac{1}{2}$
- C. 2
- D. 4

Turn over

17. A cell has an emf of 3.0V and an internal resistance of 2.0Ω. The cell is connected in series with a resistance of 10Ω.

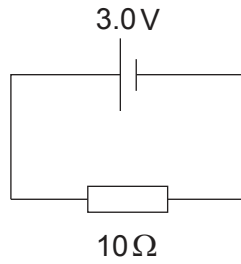

What is the terminal potential difference of the cell?

- A. 0.5V
 - B. 1.5V
 - C. 2.5V
 - D. 3.0V
18. Two parallel wires carry equal currents in the same direction out of the paper. Which diagram shows the magnetic field surrounding the wires?

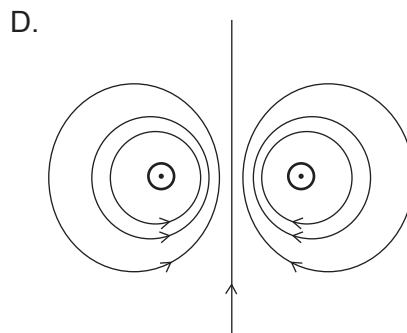
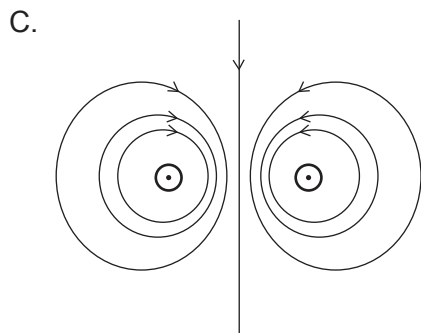
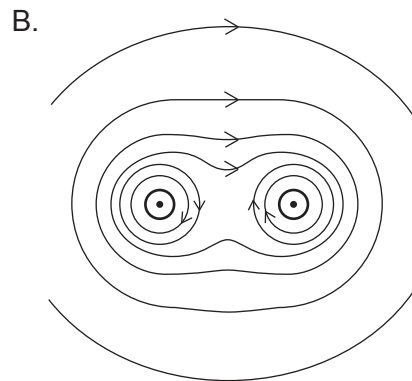
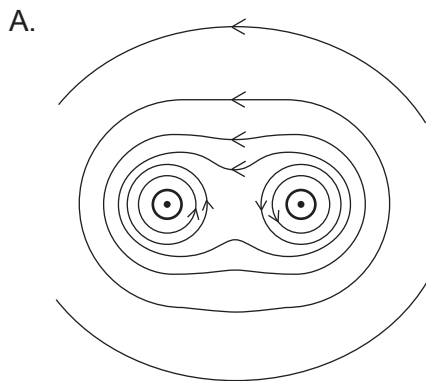

19. A mass at the end of a string is moving in a horizontal circle at constant speed. The string makes an angle θ to the vertical.

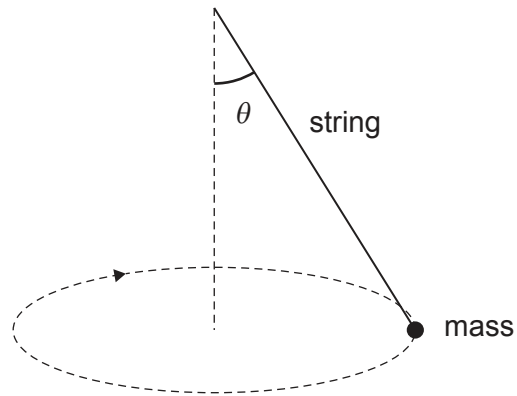

What is the magnitude of the acceleration of the mass?

- A. g
- B. $g \sin \theta$
- C. $g \cos \theta$
- D. $g \tan \theta$

Turn over

20. A detector measures the count rate from a sample of a radioactive nuclide. The graph shows the variation with time of the count rate.

The nuclide has a half-life of 20 s. The average background count rate is constant.

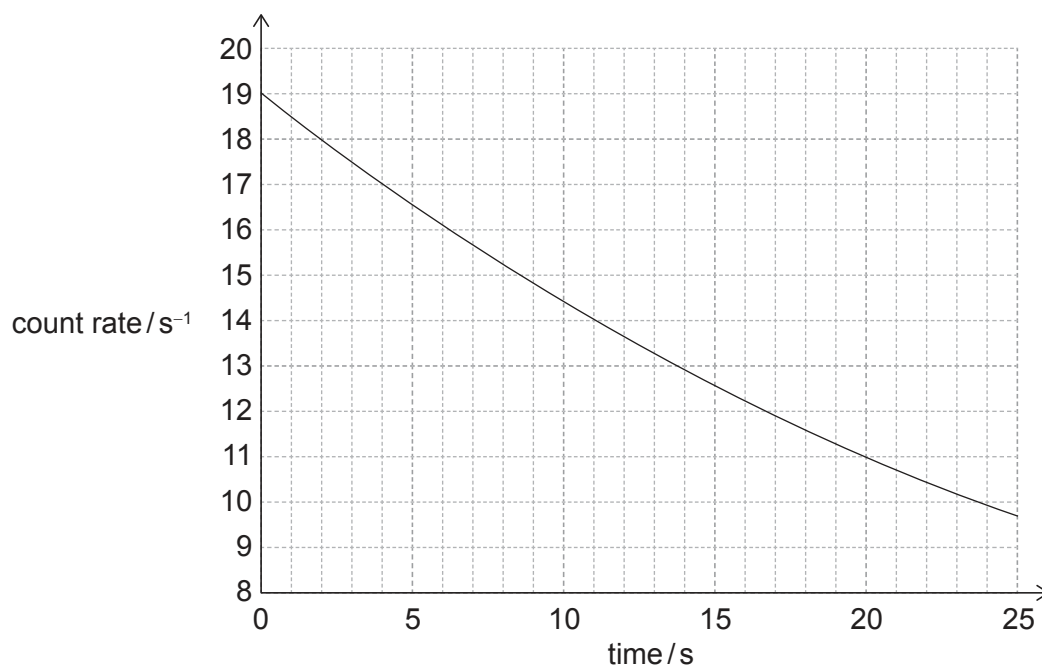

What is the average background count rate?

- A. 1 s^{-1}
 - B. 2 s^{-1}
 - C. 3 s^{-1}
 - D. 4 s^{-1}
21. The mass of a nucleus of iron-56 (${}^{56}_{26}\text{Fe}$) is M .

What is the mass defect of the nucleus of iron-56?

- A. $M - 26m_p - 56m_n$
- B. $26m_p + 30m_n - M$
- C. $M - 26m_p - 56m_n - 26m_e$
- D. $26m_p + 30m_n + 26m_e - M$

22. The Feynman diagram shows an interaction between a proton and an electron.

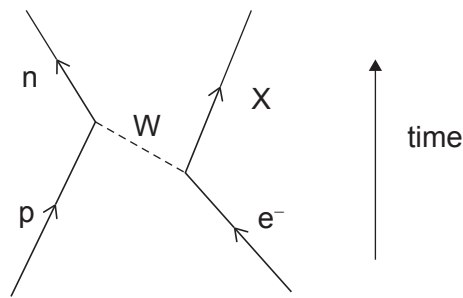

What is the charge of the exchange particle and what is the lepton number of particle X?

	Charge of the exchange particle	Lepton number of particle X
A.	-e	-1
B.	-e	+1
C.	+e	-1
D.	+e	+1

23. The Higgs boson was discovered in the Large Hadron Collider at CERN. Which statements are correct about the discovery of the Higgs boson?

- I. It was independent of previous theoretical work.
- II. It involved analysing large amounts of experimental data.
- III. It was consistent with the standard model of particle physics.

- A. I and II only
- B. I and III only
- C. II and III only
- D. I, II and III

Turn over

24. A fuel has mass density ρ and energy density u . What mass of the fuel has to be burned to release thermal energy E ?

- A. $\frac{\rho E}{u}$
- B. $\frac{u E}{\rho}$
- C. $\frac{\rho u}{E}$
- D. $\rho u E$

25. The diagram shows a simple model of the energy balance in the Earth surface-atmosphere system. The intensities of the radiations are given.

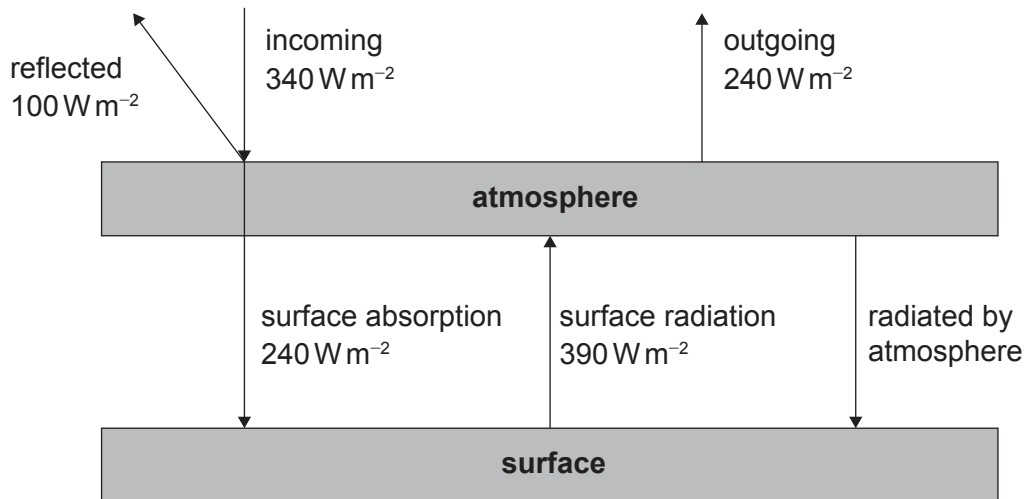

What is the average intensity radiated by the atmosphere towards the surface?

- A. 100 W m^{-2}
- B. 150 W m^{-2}
- C. 240 W m^{-2}
- D. 390 W m^{-2}

26. A simple pendulum undergoes simple harmonic motion. The gravitational potential energy of the pendulum is zero at the equilibrium position. How many times during **one** oscillation is the kinetic energy of the pendulum equal to its gravitational potential energy?
- A. 1
 - B. 2
 - C. 3
 - D. 4
27. When monochromatic light is incident on a single slit a diffraction pattern forms on a screen. The width of the slit is decreased.

What are the changes in the width and in the intensity of the central maximum of the diffraction pattern?

	Width of the central maximum	Intensity of the central maximum
A.	increases	increases
B.	increases	decreases
C.	decreases	increases
D.	decreases	decreases

Turn over

28. Monochromatic light of wavelength λ in air is incident normally on a thin liquid film of refractive index n that is suspended in air. The rays are shown at an angle to the normal for clarity.

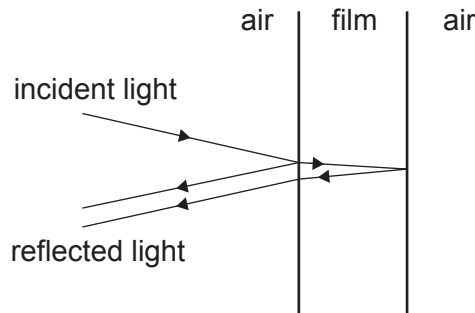

What is the minimum thickness of the film so that the reflected light undergoes constructive interference?

- A. $\frac{\lambda}{4n}$
 - B. $\frac{\lambda}{3n}$
 - C. $\frac{\lambda}{2n}$
 - D. $\frac{\lambda}{n}$
29. A beam of light containing two different wavelengths is incident on a diffraction grating. The wavelengths are just resolved in the third order of diffraction.

What change increases the resolution of the image?

- A. Increasing the width of the incident beam
- B. Increasing the intensity of light
- C. Decreasing the number of lines per unit length in the diffraction grating
- D. Decreasing the order of diffraction

30. The diagram shows equipotential lines for an electric field. Which arrow represents the acceleration of an electron at point P?

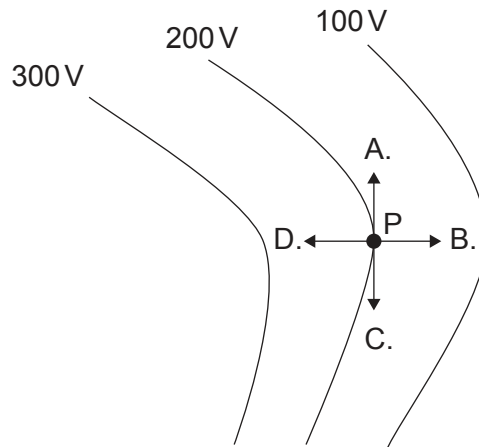

31. Two charged parallel plates have electric potentials of 10V and 20V.

20V 

10V 

A particle with charge $+2.0 \mu\text{C}$ is moved from the 10V plate to the 20V plate. What is the change in the electric potential energy of the particle?

- A. $-20 \mu\text{J}$
- B. $-10 \mu\text{J}$
- C. $10 \mu\text{J}$
- D. $20 \mu\text{J}$

Turn over

32. A satellite of mass m orbits a planet of mass M in a circular orbit of radius r . What is the work that must be done on the satellite to increase its orbital radius to $2r$?

- A. $\frac{GMm}{r}$
- B. $\frac{GMm}{2r}$
- C. $\frac{GMm}{4r}$
- D. $\frac{GMm}{8r}$

33. A small magnet is released from rest to drop through a stationary horizontal conducting ring.

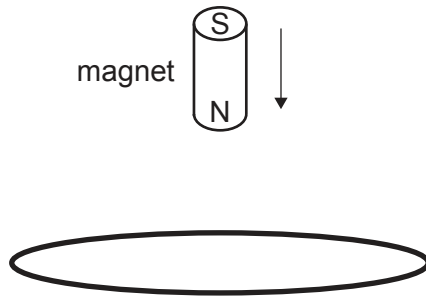

What is the variation with time of the emf induced in the ring?

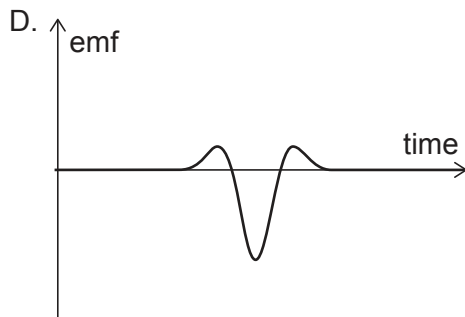
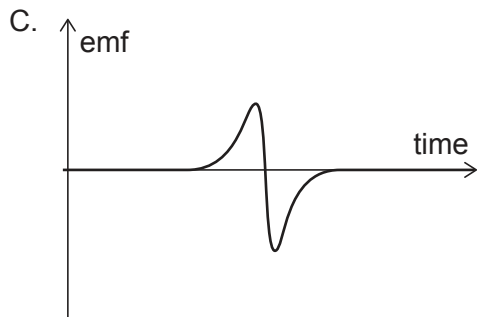
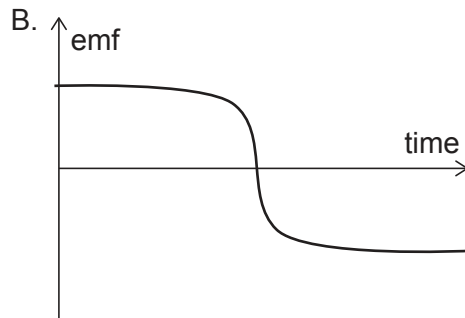
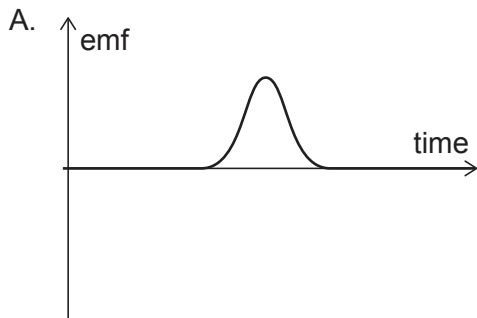

34. An alternating supply is connected to a diode bridge rectification circuit.

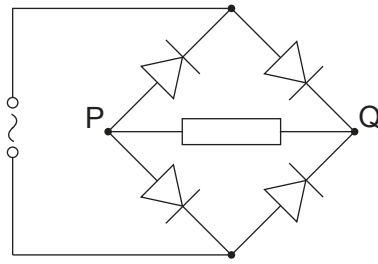

The conventional current in the load resistor

- A. is a maximum twice during one oscillation of the input voltage.
 - B. is never zero.
 - C. has a zero average value during one oscillation of the input voltage.
 - D. can only flow from P to Q.
35. The root mean square (rms) current in the primary coil of an ideal transformer is 2.0A. The rms voltage in the secondary coil is 50V. The average power transferred from the secondary coil is 20W.

What is $\frac{N_p}{N_s}$ and what is the average power transferred from the primary coil?

	$\frac{N_p}{N_s}$	Average power transferred from the primary coil / W
A.	$\frac{1}{5}$	4.0
B.	5	20
C.	$\frac{1}{5}$	20
D.	5	100

Turn over

36. Two initially uncharged capacitors X and Y are connected in series to a cell as shown.

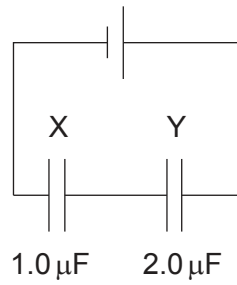

What is $\frac{\text{voltage across X}}{\text{voltage across Y}}$?

- A. $\frac{1}{2}$
- B. 1
- C. 2
- D. 4
37. In a photoelectric experiment a stopping voltage V required to prevent photoelectrons from flowing across the photoelectric cell is measured for light of two frequencies f_1 and f_2 . The results obtained are shown.

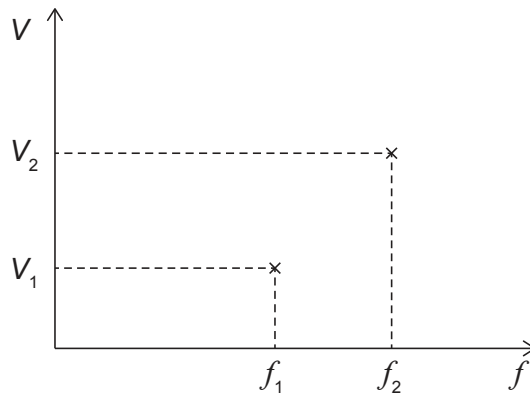

The ratio $\frac{V_2 - V_1}{f_2 - f_1}$ is an estimate of

- A. e
- B. h
- C. $\frac{e}{h}$
- D. $\frac{h}{e}$

38. A beam of electrons moving in the direction shown is incident on a rectangular slit of width d .

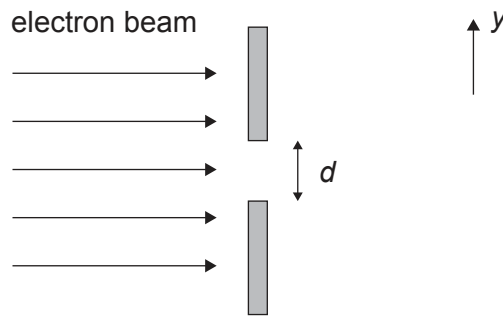

The component of momentum of the electrons in direction y after passing through the slit is p . The uncertainty in p is

- A. proportional to d
 - B. proportional to $\frac{1}{d}$
 - C. proportional to $\frac{1}{d^2}$
 - D. zero
39. Some of the nuclear energy levels of oxygen-14 (^{14}O) and nitrogen-14 (^{14}N) are shown.

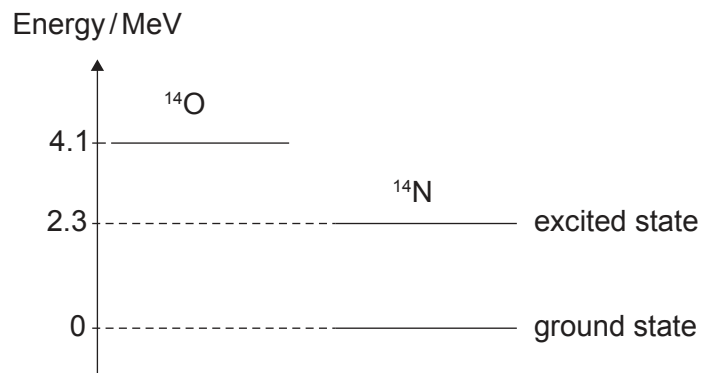

A nucleus of ^{14}O decays into a nucleus of ^{14}N with the emission of a positron and a gamma ray. What is the maximum energy of the positron and the energy of the gamma ray?

	Maximum energy of the positron/MeV	Energy of the gamma ray/MeV
A.	1.8	2.3
B.	1.8	4.1
C.	2.3	1.8
D.	4.1	2.3

Turn over

40. The size of a nucleus can be estimated from electron diffraction experiments. What is the order of magnitude of the de Broglie wavelength of the electrons in these experiments?
- A. 10^{-15} m
 - B. 10^{-13} m
 - C. 10^{-11} m
 - D. 10^{-9} m
-

References:

© International Baccalaureate Organization 2021